

INTERFELS

Geotechnische Meßgeräte

Herstellung - Einbau - Meßwerterfassung

Durchführung von Messungen

Hoch- und Tiefbau; Bergbau

Geotechnical Instruments

Manufacturing - Installation - Data Acquisition

Testing Services

Civil- and Mining Engineering

Mobile Probe Extensometer INCREX

INTERFELS Borehole Instruments

Product No. 122

Instruction Manual

(09/97)



Tradition - Innovation

Summary

The INCREX (INCRemental Extensometer) is designed for measuring the deformation of boreholes in direction of the borehole axis at regular distances. For the measurements use is made of a mobile borehole probe. Due to the contact-free, electronic determination of the actual distances between 2 neighboured measuring marks, a very high system accuracy is reached by INCREX.

A conventional inclinometer measurement can be combined with a standard INCREX measurement. This allows the determination of the change in deformation of a borehole in 3-D.

The INCREX measuring system is designed for on-site conditions. It is quite robust and dust- and waterproof. Despite of this design care is necessary to make the best use of this precision borehole instrument over its entire life time.

The way of carrying out successful INCREX measurements is described in this Instruction Manual.



CONTENT	Page
Summary	1
Introduction.....	3
1. Handling of the instruments	4
2. Carrying out INCREX Measurements	5
2.1 General remarks	5
2.2 Preparation for a measurement.....	8
2.3 Moving the Probe into Measuring Position	9
2.4 Measuring	11
3. Functional Control	13
4. Hardware Maintenance	14
4.1 Mechanism, Screw Connections, O-Rings	14
4.2 Batteries and Power Supply.....	14
Appendix 1 INCREX – Measuring Principle	15

Introduction

The contact-free mobile extensometer INCREX is particularly suitable for the in-situ determination of settlement profiles, loosening and movements of the ground (as well in combination with inclinometer measurements) in the vicinity of underground openings; in slope and foundation engineering; applicable to rock construction in both civil and mining engineering.

It is designed for highly accurate measurements of the distance between regularly spaced measuring marks which are part of the borehole casing. It is therefore the axial component of the movement of the borehole which is measured.

For an INCREX measurement an ABS casing is inserted in the borehole. On its outer side the casing is carrying metallic measuring rings which are spaced at regular intervals (standard = 1.0 m). The annulus between casing and borehole wall is filled with a mortar based grout to provide a bond between the ground and the measuring rings. The exact distance between adjacent measuring rings is measured by the INCREX probe which is inserted into the casing from outside of the borehole. Built-in the INCREX probe are two high precision coil systems at a base distance of 1.000 m. In measuring position the two coil systems of the probe are in induction with the two measuring rings. This provides an electrical signal which is proportional to the actual distance of the two measuring rings. The INCREX signal is the difference between the base length of the coils (constant at 1.000000 m) and the distance of the two actual measuring rings. A typical signal is 0.123 mm which means that the two rings are 1.000123 m apart.

By repeated measurements in certain time intervals (typically days, weeks or months) settlements, loosening processes and, in combination with mobile inclinometers, also general 3-D displacements can be recorded.

The INCREX probe is waterpressure-proof up to 15 bars. It has a standard length of 1550 mm and an outer diameter of 46 mm. Centering of the probe in the tubing is by two spring-loaded wheels as with standard mobile inclinometers. The probe fits into inclinometer tubings of 60 mm inner diameter.

The components of movements **across** the borehole axis can be measured by conventional digital mobile inclinometers. **Both mobile probes (INCREX and Inclinometer) can be employed in one and the same borehole casing. By this you can determine the general 3-D displacements at measuring points spaced at 1.0 m in nonhorizontal boreholes.**

1. Handling of the instruments

The INCRemental EXtensometer is a precision instrument of **very high accuracy**. The system is to be **handled with due care** to enjoy a good functioning over its life time. The readout unit or the data acquisition and computer assembly, respectively, as well as cable and cable heads should not be subject to excessive moisture, dust and vibrations.

It is highly recommended to read all delivered manuals carefully. When using a notebook basic knowledge of handling a computer is required.

The computer and the data acquisition unit have separate batteries. The battery of the data acquisition system provides the transducers with power as well. A battery charger of 220 V / 50 Hz is already installed. The actual voltage of the battery is displayed on the measuring screen of the notebook as well as on the readout unit by pushing the button.

As a complete measurement often exceeds the operation time of storage batteries we recommend to operate both computer and data acquisition system by the electric mains whenever this is possible.

In case this is not practicable in the fields, INTERFELS offers a 12V-power-box which is constructed especially for field use as external power supply for computer and data acquisition system. For this the computer has to be equipped with a standard 12V-car-adapter.

With a fully recharged battery the data acquisition system is able to operate for about 8 hours without external power supply.

All instruments and batteries should be recharged between the measurements. Before starting a new measurement please check the voltage of the data acquisition unit by pushing the corresponding button. The battery voltage should be at least 12.5 V without the mains cable connected.

In case of de-commissioning the system over an extended period of time, check the state of the batteries every 3 months and recharge them, if necessary.

2. Carrying out INCREX Measurements

2.1

General remarks

- Before starting the measurements, check that the grout is sufficiently set.
- Prior to the first measurement, a functional control of the INCREX system is recommended (ref. chap. 3). For this, insert the INCREX probe into the tube for the functional control which is usually supplied. It is recommended to store the functional control tube at a place with nearly constant ambient temperatures.
- Note that one set of INCREX measurements consists of two measuring runs over the entire depth. When working with the automatic data acquisition in the fields these two runs will be checked and averaged by the computer.
- **The direction of measuring for each run is always from the bottom to the top of the borehole.**
Each complete measurement therefore consists of two upward runs.
- **Before starting the measurement leave the probe at least for 30 minutes at the bottom of the borehole in order to adjust the temperature of the probe to the surrounding and wait until the value has stabilized.**
- It is necessary to repeat this control before starting the second upward run. The temperature of the probe has to be constant.
- For maximum accuracy allow for approximately identical temperature adjustment periods for each new INCREX run. Also carry out the INCREX measurements at about the same speed. This is especially important in very deep boreholes and for measurements near the surface.
- The probe should always be inserted into the tubing in the same orientation. It may be useful to mark one groove of the tubing.
- A more detailed description of all necessary steps for a successful INCREX measurement is given in the following sections. This description explicitly refers to a system with a data acquisition and computer unit. The measurements by using a more conventional battery-operated readout unit are virtually the same, besides that the INCREX readings must be recorded by hand.

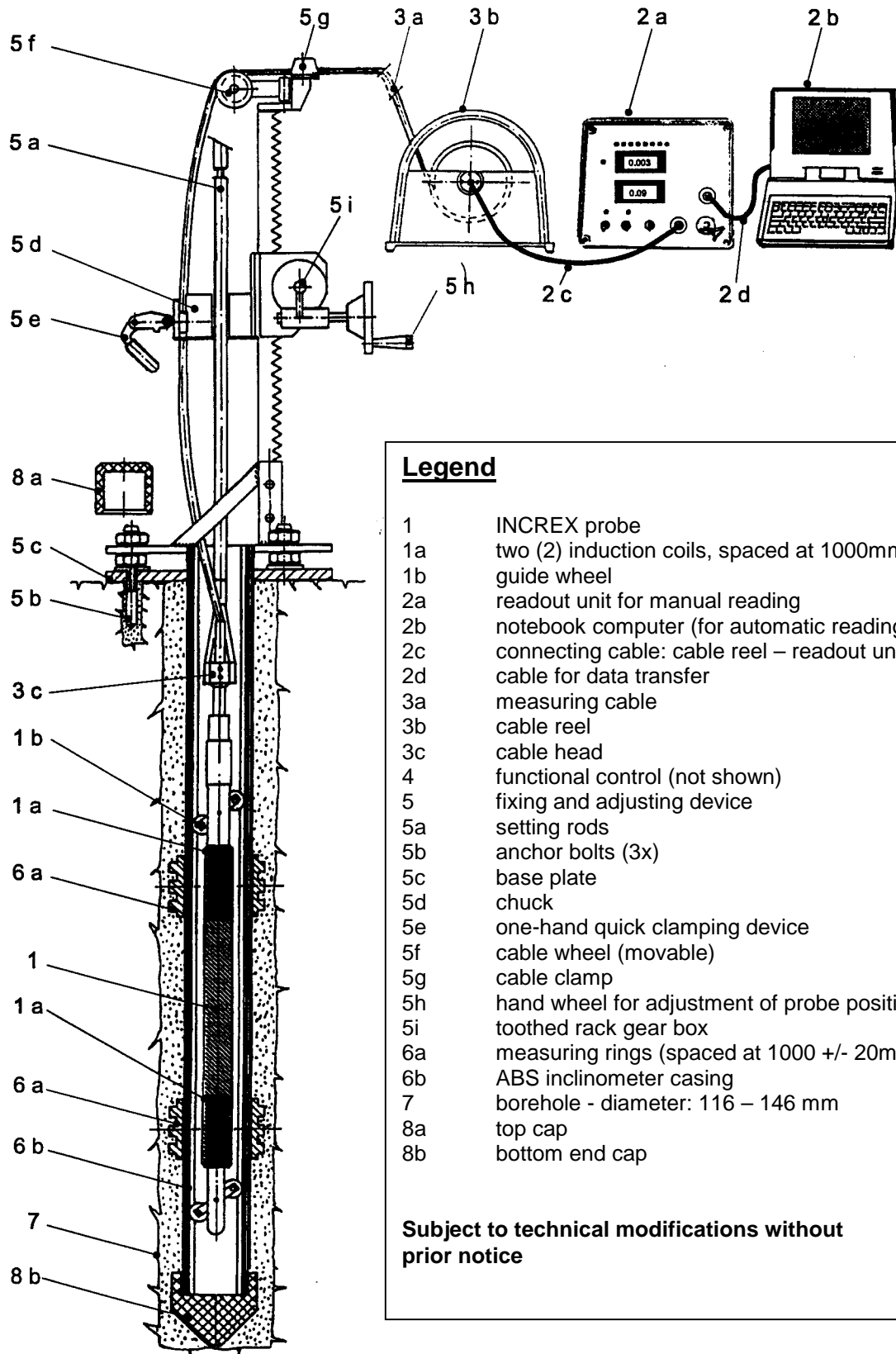

Legend

- 1 INCREX probe
- 1a two (2) induction coils, spaced at 1000mm
- 1b guide wheel
- 2a readout unit for manual reading
- 2b notebook computer (for automatic reading)
- 2c connecting cable: cable reel – readout unit
- 2d cable for data transfer
- 3a measuring cable
- 3b cable reel
- 3c cable head
- 4 functional control (not shown)
- 5 fixing and adjusting device
- 5a setting rods
- 5b anchor bolts (3x)
- 5c base plate
- 5d chuck
- 5e one-hand quick clamping device
- 5f cable wheel (movable)
- 5g cable clamp
- 5h hand wheel for adjustment of probe position
- 5i toothed rack gear box
- 6a measuring rings (spaced at 1000 +/- 20mm)
- 6b ABS inclinometer casing
- 7 borehole - diameter: 116 – 146 mm
- 8a top cap
- 8b bottom end cap

Subject to technical modifications without prior notice

Figure 1 : INCREX Measuring System and Tubing

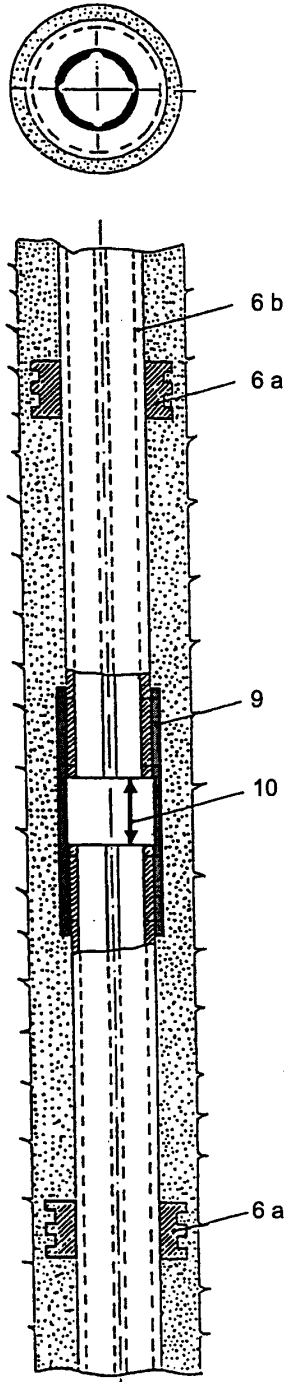

Legend

- 6a measuring rings
 central distance = 1 000 mm
 outer diameter = 86 mm
 - 6b ABS inclinometer casing
 outer diameter = 70 mm
 inner diameter = approx. 60 mm
 length = 3 000 mm
 - 9 sleeve for inclinometer casing
 outer diameter = 77.5 mm
 inner diameter = 70.2 mm
 length = 300 to 1 000 mm
 - 10 gap between adjacent ends of
 inclinometer casings
 up to 100 mm,
 in special cases even more
- Note: sleeve (9) and gap (10) are missing
 at inclinometer tubes with snap seal
 O-ring coupling

**Subject to technical modifications
without prior notice**

Figure 2: INCREX Tubing

2.2 Preparation for a measurement

Please refer to figures 1 and 2.

1. After having removed the protection caps connect the cable head (3c) of the measuring cable on the cable reel (3b) to the INCREX probe (1).

!! Warning !! When connecting the cable with the probe, take care not to tighten the nut too rigorously. Otherwise the plug might be bent or even destroyed. Take note that the O-ring is in its correct position and that coupling and thread are clean. The O-ring should be occasionally treated with acid-free vaseline. Carefully tighten the cap nut by an open-ended spanner whilst holding the INCREX probe in the other hand until the slackness of the plug has just disappeared.

Connect also the cable reel with the readout unit (2a). The computer (2b) will be connected via the RS232-port COM1 or COM2 with the data cable (2d) to the readout unit.

2. Setup of the fixing and adjusting device (5) on top of the borehole.
3. Insert the probe (1) into the borehole by feeding it through the fixing and adjusting device (5).

Attention: For good measurements the INCREX probe must be inserted into the tubing always in identical orientation. This is facilitated by marking the keyway in the appropriate direction.

4. Open chuck (5d) of the clamping device by activating lever (5e). Feed a setting rod (5a) from the top into the clamping device.
5. Connect INCREX probe to the setting rod (quick coupling).
6. Tighten chuck by means of lever. Feed measuring cable (3a) of the probe through the slot of the cable clamp (5g) and fix it.
7. Screw the fixing and adjusting device onto the anchor bolts (5b) of the base plate (5c) on top of the borehole.
8. For measuring open chuck of the clamping device to release the setting rod. The setting rods are connected by the quick couplings. In order to control the measuring depth and position write down the number of setting rods. Each setting rod is 2m long with a black mark at 1m.

2.3 Moving the Probe into Measuring Position

Please refer to figure 1 and appendix 1.

The readout unit has on its front panel at the top an array of luminous diodes, right below the measuring value (deviation of the distance of the measuring rings from the rated value of 1.0 m) and at the bottom the display of the position of the probe (deviation from the optimum position between the measuring rings).

By pushing the appropriate marked buttons the voltage of the readout unit and the temperature of the probe respectively can be displayed.

The correct measuring position of the probe with regard to the actual two measuring rings is indicated by the array of luminous diodes as well as by the LCD window display at the readout unit.

The maximum measuring accuracy can only be obtained in the correct measuring position which corresponds to a position value of -0.50 and $+0.50$. Within this range the measuring value will be stable and can be saved.

When working with a computer the actual position of the probe (in mm) and the actual measuring value is also displayed on the measuring screen. Additionally there will appear a luminous beam at the bottom of the screen if the position of the probe is between -2.00 and $+2.00$ mm.

Note: It is recommended to use the much faster display of the luminous diodes as well as the LCD display of the readout unit to position the probe.

When the induction coils do approach a pair of measuring rings the luminous diodes will turn on. By moving the probe further into measuring position, the array of diodes is triggered in such a way that the illuminated diodes are first consecutively turned out, then for a short distance are left turned out, and then, on further slight movement, been turned on, again consecutively.

When moving the probe in the borehole, the steady pace of turning off and on of the luminous diodes is a clear indication that the INCREX probe is in a correct measuring position. The position in which an INCREX reading can be taken is in the range when all diodes are extinguished. By slight movements in both directions the diodes will turn on again.

On the LCD you will notice a change in sign of the position of the probe while moving it. The probe is in exact measuring position when the reading is zero. As mentioned above the measuring value will be stable in the range of ± 0.50 mm.

To keep the probe steady in a measuring position, it is important to lock the probe and the string of setting rods (5a) at the clamping device (5e). The measuring

cable (3a) should be fixed in the cable clamp (5g). A steady position of the probe is a precondition for a good measurement.

When locking the setting rods by activating lever the probe is normally not exactly in measuring position. For fine tuning rotate hand wheel (5h) until the LCD value is sufficiently close to zero.

!! Attention !!: Take care not to stretch the measuring cable in the cable clamp too hard when moving the chuck with the setting rods downwards. In this case release the cable for a short while.

When moving the INCREX probe into a new measuring position, it is of advantage to observe the markings on the setting rods as it allows quick finding of the approximate measuring position.

Note: When the probe is far away from a measuring position (say by about more than 10 cm), all of the diodes are usually extinguished. In case, however, that the probe is moving into a position with only a single measuring ring (this normally is only the case at the top of the borehole) or the borehole is intercepting a magnetically or electrically active zone, the array of diodes might be illuminated even if far away from a measuring position. In this situation a very quick and more irregular activation of the array of diodes is characteristic.

In case of strong magnetic or electric disturbances (magnetic orebodies or wireless), it might happen that the array of diodes are constantly activated over a certain length of borehole or period of time. In this case either switch off the INCREX data acquisition for a short while. Alternatively, wait until the disturbances have disappeared or waive INCREX measurements in this particular zone.

2.4 Measuring Procedure

9. After preparation as described before switch on the data acquisition unit and also the portable computer.
10. Insert the probe into the borehole. Proceed straight to the bottom of the borehole without taking any readings.
11. Move the probe to the correct measuring position of the two lowermost measuring rings.
12. After initiating the INCREX measurements in the computer program (refer to software manual), leave the probe at least for 30 minutes at the lowermost measuring point in order to adjust the probe temperature to the temperature in the borehole.
13. Once the temperature of the probe has stabilized start with the INCREX measurements by pressing <Enter>. This action will be confirmed by an acoustic signal. The measuring point number and depth will be displayed inversely on the computer screen.
14. In a measuring position the actual INCREX value is internally recorded a number of times and checked on its repeatability before being accepted and stored by the computer. Because of the internal checks in the computer the measuring period may last a number of seconds. **It is important not to move the probe during this measuring period.** A second acoustic signal indicates the reading is finished successfully. Furthermore the inverse display of the computer screen will be made undone.
 On the readout unit and the computer screen respectively, two values are displayed:
 - The **INCREX value** is the distance of the measuring rings minus the base length of 1.00 m. An INCREX value of 0.000 mm therefore indicates a distance of the measuring rings of exactly 1 000.000 mm.
 - The **position** of the probe indicates the departure of the probe from its exact central position between the two measuring rings. The position is displayed during the measurement and is also recorded on the computer for documentation purposes, despite the fact that this value is not needed in the evaluation of the INCREX measurements.

It is recommended to place the probe as accurate as +/- 0.5 mm into the exact position. The computer controls the position of the probe and provides an error message if the probe is out of its ideal position by more than +/- 5 mm. In this case the probe has to be repositioned and the measurement restarted by pressing the <Enter> key.

15. After completion of the first measuring run (probe at the collar of the borehole), press <Ctrl>+<End> simultaneously on the computer. This is followed by the initiation input for the second run or the end of the measurement respectively.
16. Again lower the probe to the bottom of the borehole and move into the first (deepest) measuring position. Check that the temperature of the probe is constant.
17. Computer commands and carrying out the measurements are completely identical with the first measuring run. At each measuring location the second measurement is immediately compared by the computer with that of the first run. If there is a discrepancy between the two readings a message is given by the computer, and the measurement can be repeated by the operator.
18. After completion of the second measuring run (probe at the collar of the borehole), press <Ctrl>+<End> simultaneously on the computer and choose the option "End of measurement". The readings will be saved and can now be evaluated.

Note that one complete set of INCREX measurements consists of two runs of the probe from the bottom to the top of the borehole !

3. Functional Control

The Functional Control of the INCREX probe is done by inserting the probe into the control tube which is supplied with each INCREX standard set. The Functional Control should be carried out at constant ambient temperature. For this, it is recommended to store the tube in a temperature-controlled room.

There are no regulations made by INTERFELS when to carry out a functional control. But we recommend a control of the probe before and after a series of measurements.

Note that in normal circumstances the factory-set offset values are very constant over years and that changes of the offset values should only be implemented after very careful testing, considering all relevant ambient factors. If in doubt, leave the offset values unchanged. In many applications this has proven to be a variable option.

In case that the INCREX value in the control tube has changed significantly despite constant ambient conditions, please contact INTERFELS to make sure the changes are not caused by other effects.

The functional control is carried out almost like a normal INCREX measurement, i.e. after achieving temperature constancy of the probe (check temperature readout). When use is made of the portable readout unit, the value has to be recorded manually. In case that a computer is used, the reading will be done automatically (refer to the Software Manual of the program INCREX-E.EXE). Carry out about 10 readings for each distance to control for more accurate mean value determination.

4. Hardware Maintenance

The INCREX system requires hardly any maintenance. The electrical signal of the probe is by induction and is generated without any mechanical contacts. All what is required is some attention to the following minor mechanical and electronic components

4.1 Mechanism, Screw Connections, O-Rings

- Guide wheels occasionally require some drops of oil.
- All connections, either mechanical or electrical (plugs), should be kept free of water and dirt.
- The O-ring between INCREX probe and measuring cable occasionally needs some acid-free grease. It should be kept free of dirt.
- Plugs which became damp during the measurement should dry before putting on the protection caps.

4.2 Batteries and Power Supply

- Computer and the data acquisition unit are individually equipped with rechargeable batteries. At commencement of each INCREX measuring day, the two batteries should be fully charged (overnight charging). Note that complete unloading or low-level loading over an extended period of time will result in permanent damage to the batteries. Therefore we recommend to recharge the batteries at least every 3 months.

INCRESX – Measuring Principle

Appendix 1 INCRESX – Measuring Principle

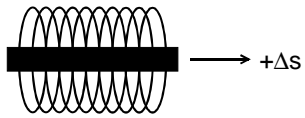

LVDT

Linear Variable Displacement
Transducer = Coil with core

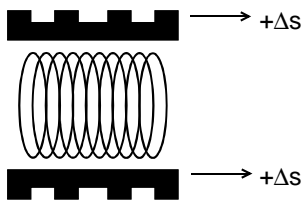
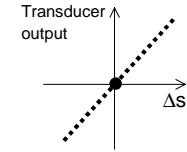

Modified LVDT

LVDT with "external core" = ring

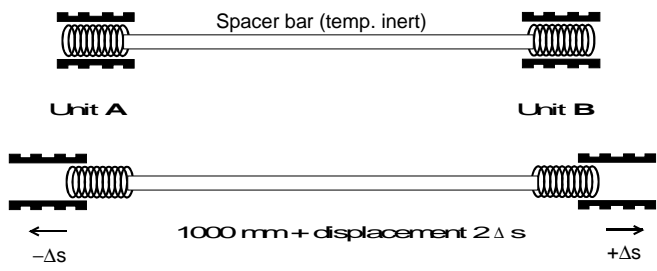
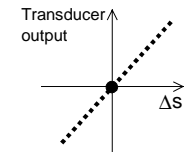

"INCRESX"
Two coil / ring Units
A and B

Displacement
of INCRESX rings
(extension = positive)

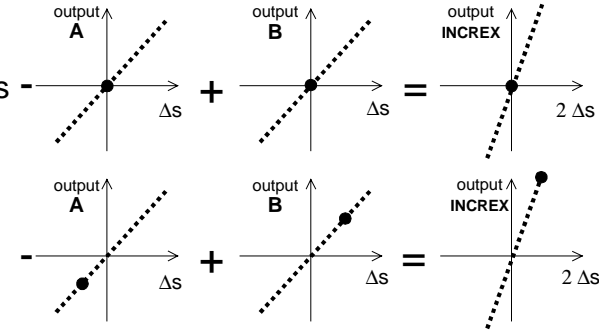

● = Actual Measuring value

Criterion for INCRESX probe in measuring position: $B + A \stackrel{!}{=} 0 = R_{pos}$	then \longrightarrow	INCRESX Signal: $B - A = R_{INCRESX}$ with: Extension $R_{INCRESX} > 0$ Compression $R_{INCRESX} < 0$
R_{pos} = Reading of "Position of Probe"		